

- B 193
- B 350
- B 393
- B 550
- RB 400**
- BH 360
- BH 550
- BH 900
- B 1025
- B 120
- BH1100
- BH1300
- BH1600
- B 3200
- B 4600

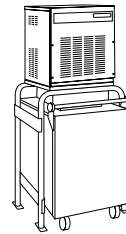

RB 400 with MF 41  
(sold separately)

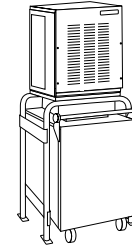

RB 400 with FME 804/1204  
(sold separately)

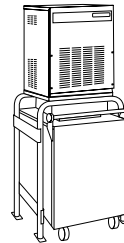

RB 400 with MF 51  
(sold separately)



Ice Storage  
Bin



Cabine  
de Stockage

Eisspeicher



Cabina  
Almacenadora

Contentitore  
Ghiaccio

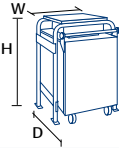
	FLAKE ICE 			
	[kg]	(lbs)	[WxDxH mm]	[WxDxH inches]
RB 400 S-Bin Only	200	440	673x1011x985	26 8/16"x39 13/16"x38 12/16"
RB 400 S-Stand Only	-	-	754x960x1120	29 11/16"x37 13/16"x44 2/16"

**2**  
Years Warranty  
Ans de Garantie  
Jahre Garantie  
Años de Garantía  
Anni di Garanzia

Subject to certain limitations and exclusions  
Assujettie aux limites et exclusions prescrites  
Abhängig von Bestimmten Einschränkungen und Ausnahmen  
Sumitido a algunas limitaciones y exclusiones  
Soggetta ad alcune limitazioni ed esclusioni





This product qualifies for the following listings:

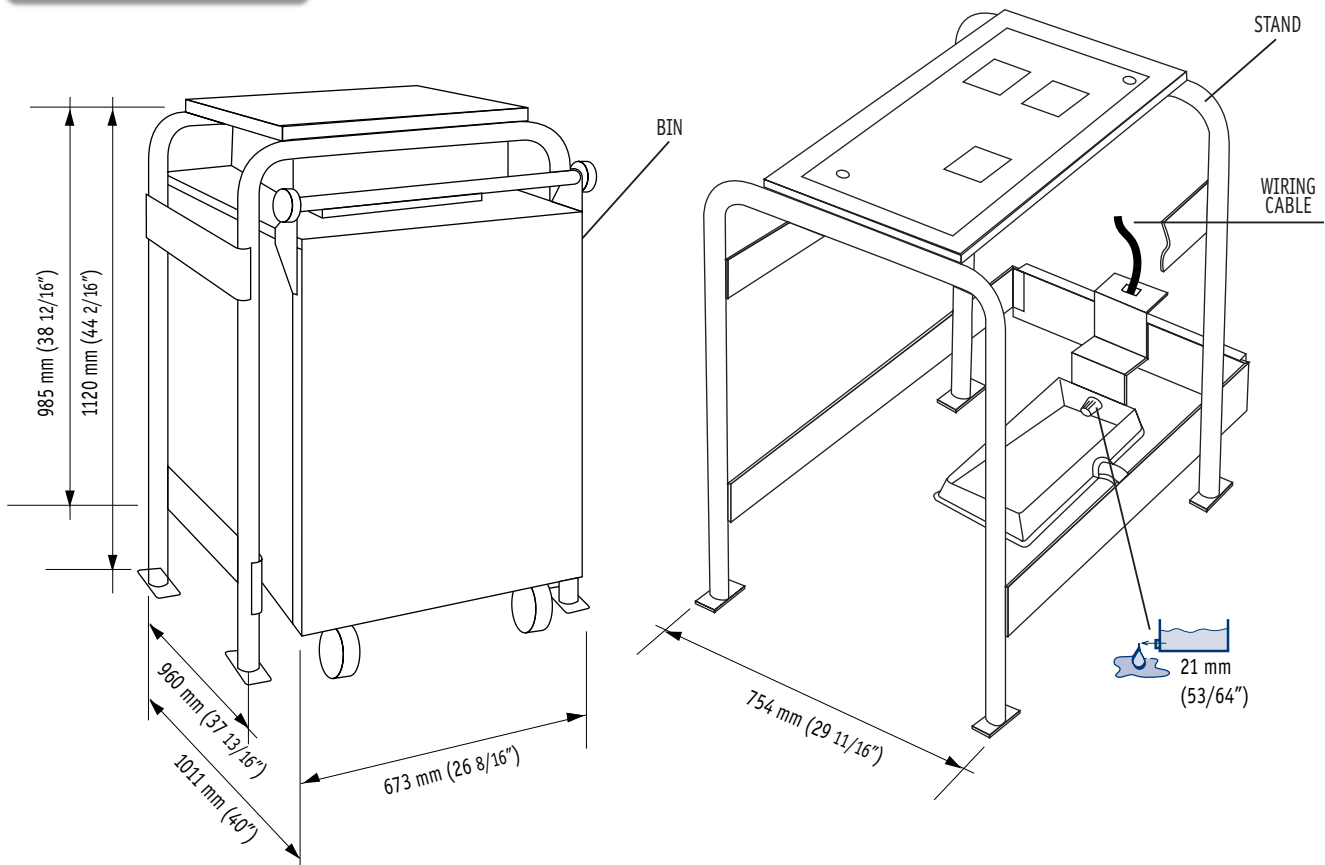

Models and specifications are subject to change without notice - Les modeles et les caracteristiques des appareils peuvent être changés sans préavis - Wir behalten das Recht vor jederzeit Änderungen der Modelle und der technischen Angaben vorzunehmen.  
Los modelos y las características pueden ser modificados en cualquier momento y sin aviso - I modelli e le specifiche possono essere cambiate in qualunque momento senza preavviso

# RB 400



				
	[kg]	[lbs]	[kg]	[lbs]
RB 400 (Bin only)	53	117	66	146
RB 400 (Stand only)	40	88	47	103

This mobile ice storage bin provides a quick and practical means of transportation of flake ice for the preparation of produce displays, service counters and cold buffets. Equipped with a large liner, the RB 400 Roller Bin was specifically developed for the use with MF 30, FME 804, FME1204, NME 654, MF 41 and 51 ice makers. Mounted on 4 nylon wheels, 2 of which swiveling, the RB 400 is easy to guide everywhere. A sliding door on the upper hatch prevents contamination of the ice during transport.

Montée sur roulettes, cette cabine permet le transport pratique et efficace de grands volumes de glace en grains pour comptoirs de vente et étales réfrigérés. Conçue exprès pour être assemblée aux machines modulaires MF 30, FME 804, FME 1204, NME 654, MF 41 et 51, RB 400 est une cabine de stockage de très grande capacité. Ce modèle est pourvu de quatre roues en nylon (dont deux pivotantes) et peut donc être aisément transporté. L'ouverture supérieure pour empêcher toute contamination.

Dieser fahrbare Eisbehälter ermöglicht den praktischen Transport von Flockeneis, während der Vorbereitung von Verkaufsflächen und Auslagen für Lebensmittel.

Der Speicher ist speziell für MF 30, FME 804, FME 1204, NM 654, MF 41 und 51, entwickelt worden. Der RB 400 verfügt über eine gräumige Speicherzelle und ist mit Nylonaufrädern versehen (welche das Lenken erleichtern). Die obere Öffnung ist durch eine verschließbare Schiebetür gegen Verunreinigung gesichert.

Montado sobre ruedas, este contenedor, permite transportar grandes cantidades de hielo triturado para cantidades de hielo triturado para mostradores de exposición y buffets fríos. Realizado expresamente para ser ensamblado con fabricadores modulares MF 30, FME 804, FME 1204, NME 654, MF 41 y 51. La RB 400 es una cabina almacenadora de gran capacidad. Consta de 4 ruedas (2 pivotantes) para facilitar el desplazamiento, y de una apertura superior que se cerreda mediante una trampilla deslizante en evitación de toda contaminación.

Montato su ruote, questo contenitore consente l'agevole trasporto di grandi quantità di ghiaccio granulare per banchi vendita ed esposizioni di cibi freddi. Realizzato appositamente per essere abbinato ai fabbricatori di ghiaccio MF 30, FME 804, FME 1204, NME 654, MF 41 e 51, è dotato di una capiente cella di raccolta. L'RB 400 è dotato di 4 ruote di nylon (di cui 2 pivotanti) per comodi spostamenti e di una apertura superiore che può essere chiusa da un apposito sportello scorrevole, per eventuali contaminazioni.

 **Scotsman**® The one the world relies on.  
Ice Systems



**USA, Canada, Latin America**  
Scotsman Ice Systems USA  
775 Corporate Woods Parkway  
Vernon Hills, IL 60061  
Ph: (847) 215-4550  
Fax: (847) 913-9844  
customer.service@scotsman-ice.com

**Europe**  
Scotsman Europe-Frimont S.p.A.  
Via Puccini, 22  
20010 Pogliano (Milano) Italy  
Ph: (+39) 02-93960208  
Fax: (+39) 02-93960201  
scotsman.europe@frimont.it

**Asia and Pacific**  
Scotsman Ice Systems-Frimont S.p.A. (R.O.)  
627A Aljunied Road-#04-04 Biztech Centre  
Singapore 389842  
Ph: (+65) 6738 5393  
Fax: (+65) 6738 1959  
scotsice@singnet.com.sg

**China**  
Scotsman Ice Systems  
258 Tong Ren Road Golden Tower 7A  
Shanghai-200040 Peoples's Republic of China  
Ph: (+86) 21-62476056  
Fax: (+86) 21-62476126  
scotsmansh@online.sh.cn

**Middle East & N. Africa**  
Scotsman Ice Systems Dubai Office  
P.o. Box 13205 - Deira  
Dubai - U.A.E.  
Ph: +9716-5654036  
Fax +9716-5654063  
scotsman@emirates.net.ae

**South Africa**  
Scotsman Ice Systems SA (PTY) Ltd.  
10, Rhodes Street - Kensington B  
P.o. Box 44 - Riverclub 2149  
Ph: +27-11-7898400  
Fax +27-11-7898411  
scotsman@telkomsa.net