

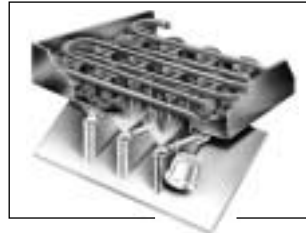

- AC 46
- AC 56
- AC 86
- AC 106**
- AC 126
- AC 176
- AC 206
- AC 226



Optional  
Progressive Water Discharge



Available as optional  
KITLEGSEXT000

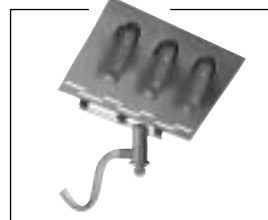

Spray bar quick disconnect



Patented anti-scale system

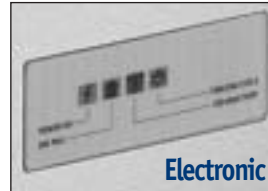

Electronic

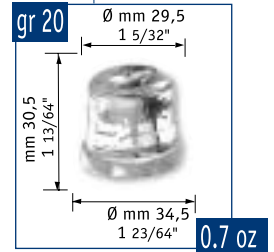

AC 106 M

0.7 oz

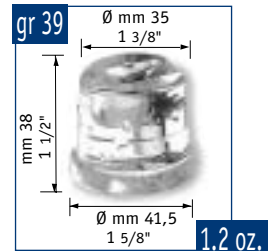

AC 106 L

1.2 oz



Proximity Condenser air filter



Routine maintenance alarm  
Front ON - OFF switch



Hygienic scoop holder



Storage bin antibacterial pouch & holder

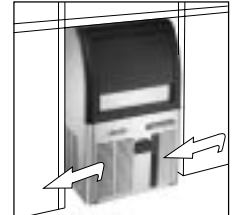

**Automatic Gourmet-Cube Ice Machine**

**Machine Automatique à Glaçons Gourmet**

**Automatischer Gourmetkegel-eisbereiter**

**Màquina Automàtica Fabricadora de Cubitos Gourmet**

**Produttore Automatico di Ghiaccio a Cubetti Gourmet**

Model	Temperature	Production Capacity						Weight	Voltage	Dimensions (mm)	Dimensions (inches)	Bin
		10°: 10°C		21°: 15°C								
		[kg]	[lbs]	N°*	[kg]	[lbs]	N°*	[kg] [lbs] N°*	[v/Hz/ph]	[WxDxH mm]	[WxDxH inches]	
ACM 106 AS	+C° -C°	50	110	2500	46	101	2300	23 50 1150	230/50/1	530x600x850/970	20"x23"x33"/38"	R 134 a
ACM106 WS		50	110	2500	46	101	2300	23 50 1150	230/50/1	530x600x850/970	20"x23"x33"/38"	R 134 a
ACL 106 AS		50	110	1280	46	101	1180	23 50 590	230/50/1	530x600x850/970	20"x23"x33"/38"	R 134 a

\*Estimate number of medium/large size gourmet cubes.  
Standard legs 120 mm high included.  
Leg extension 60 mm high available as code no. KITLEGSEXT000.  
Optional: PWD System.

[www.scotsman-ice.com](http://www.scotsman-ice.com)  
[www.scotsman-ice.it](http://www.scotsman-ice.it)

**2**

Years Warranty  
Ans de Garantie  
Jahre Garantie  
Años de Garantía  
Anni di Garanzia

Subject to certain limitations and exclusions  
Assujettie aux limites et exclusions prescrites  
Abhängig von Bestimmten Einschränkungen und Ausnahmen  
Sujeta a algunas limitaciones y exclusiones  
Soggetta ad alcune limitazioni ed esclusioni



# AC 106

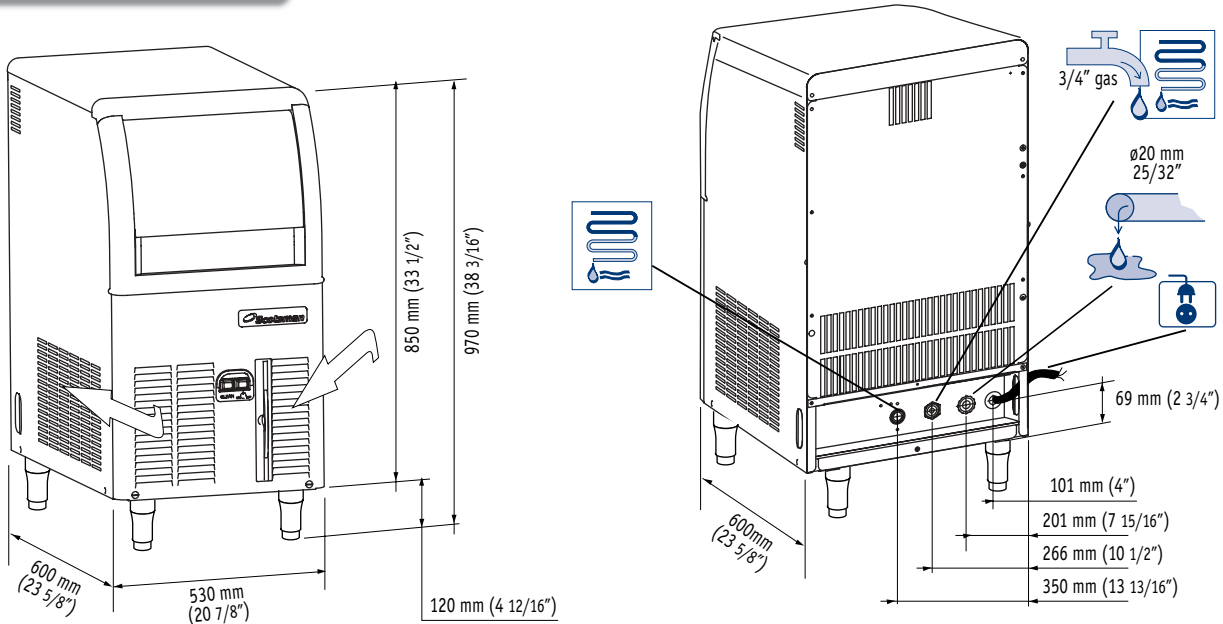

		-C° +C°	[Btu/h] [W]	[kg]	[mm <sup>2</sup> ]	[W]	FUSE [A]	[kWh]	[l/h] [gal/h]	[kg] [lbs]	[kg] [lbs]	[kg] [lbs]	[kg] [lbs]	
ACM 106 AS			4100 1200		1,5	550	10	10.3	5.5 1.5	47 103	54 119			
ACM 106 WS			4100 1200		1,5	550	10	9.4	51.5 13.5	47 103	54 119			
ACL 106 AS			4100 1200		1,5	550	10	10.9	4.2 1.1	47 103	54 109			

## AC 106 AIR COOLED



°C °F	°C				kg
	50° 10°	60° 15°	70° 21°	90° 32°	
10°	50	48.5	47	44	kg
50°	110	107	103.5	97	lbs
21°	47.5	46	44.5	41.5	kg
70°	105	101	98	91.5	lbs
32°	41	39.5	38	35	kg
90°	90.5	87	84	77	lbs
38°	38	36.5	35	32	kg
100	84	80.5	77	70.5	lbs

24h



Machine requires voltage indicated on rating name plate. Failures caused by improper voltage are not considered factory defects. Scotsman products are not designed for outdoor installation. Extended periods of operation at temperatures exceeding the above limitations constitutes misuse under the terms of Scotsman Limited Warranty, resulting in a loss.

La machine doit être raccordée conformément au voltage indiqué sur la plaque signalétique. Les éventuels dégâts causés par un non respect de cette consigne ne peuvent être considérés comme des défauts de fabrication. Les machines à glace Scotsman ne sont pas conçues pour être utilisées à l'extérieur. Le fonctionnement prolongé à des températures supérieures ou inférieures aux limites ci-dessus sont considérées comme une mauvaise utilisation dans le cadre de la garantie Scotsman.

## AC 106 WATER COOLED



°C °F	°C				kg
	50° 10°	60° 15°	70° 21°	90° 32°	
10°	50	48.5	47	44	kg
50°	110	107	103.5	97	lbs
21°	47.5	46	44.5	41.5	kg
70°	105	101	98	91.5	lbs
32°	44	42.5	41	38	kg
90°	97	93.5	90.5	84	lbs
38°	43	41.5	40	37	kg
100	95	91.5	88	81.5	lbs

24h



Der Eisbereiter benötigt eine Stromspannung gemäß Geräte-Typenschild. Störungen oder Ausfälle, durch den Betrieb mit falscher Stromspannung sind keine Fabrikationsfehler und fallen nicht unter Garantie. Scotsman Eisbereiter sind nicht für die Installation im Freien geeignet. Der längere Betrieb bei Temperaturen über den obigen Grenzwerten ist eine falsche Anwendung und bedeutet den Verlust der Garantieleistung.

Los requerimientos eléctricos de la máquina están indicados en la placa de características. Los daños causados por voltajes inadecuados no son considerados defectos de fábrica. La máquina de hielo Scotsman, no están diseñadas para trabajar a la intemperie. Largos periodos de funcionamiento a temperaturas que excedan de las limitaciones indicadas, constituyen maltrato de acuerdo con las observaciones de Scotsman.

La macchina richiede il voltaggio indicato sulla targhetta di identificazione. Danni causati da voltaggi diversi non sono considerati difetti di produzione. I prodotti Scotsman non vanno utilizzati all'aperto. Un prolungato periodo di utilizzo al di fuori delle temperature indicate non è consentito e causa l'automatico decadere della garanzia.



Minimum

10°C (50°F)



Maximum

40°C (104°F)

5°C (41°F)

-10%

1 BAR  
14 psi



+10%

+10%

5 BAR  
70 psi



**Scotsman**<sup>®</sup>  
Ice Systems

The one the world relies on.

Certified ISO 9001:2000

### USA, Canada, Latin America

Scotsman Ice Systems USA  
775 Corporate Woods Parkway  
Vernon Hills, IL 60061  
Ph: (+1) 847 215-4550  
Fax (+1) 847 913-9844  
customer.service@scotsman-ice.com

### Europe

Scotsman Europe-Frimont S.p.A.  
Via Puccini, 22  
20010 Pogliano (Milano) Italy  
Ph: (+39) 02-93960208  
Fax: (+39) 02-93960201  
scotsman.europe@frimont.it

### Asia and Pacific

Scotsman Ice Systems-Frimont S.p.A. (R.O.)  
627A Aljunied Road-#04-04 Biztech Centre  
Singapore 389842  
Ph: (+65) 6738 5393  
Fax: (+65) 6738 1959  
scotsice@singnet.com.sg

### China

Scotsman Ice Systems  
(Shanghai) Co., Ltd  
Room 405-407 Jing'an China Tower  
1701 West Beijing Road-200040 Shanghai  
Ph: (+86) 21-62476056-Fax: (+86) 21-62476126  
scotsmarsh@online.sh.cn

### Middle East & N. Africa

Scotsman Ice Systems Dubai Office  
P.o. Box 21648  
Sharjah - U.A.E.  
Mobile: Ph: (+971) 505505980  
Fax (+971) 6-5654063  
scotsman@eim.ae

### South Africa

Scotsman Ice Systems SA (PTY) Ltd.  
10, Rhodes Street - Kensington B  
P.o. Box 44 - Riverclub 2149  
Ph: (+27) 11-7898400  
Fax (+27) 11-7898411  
scotsman@telkomsa.net